

PowerKit Engine 12M33 Series

General Specifications

Bore & Stroke	150x185 mm
Displacement	39.2 L
Cylinder Number	12V
Compression Ratio	15:1
Fuel System	Mechanical Pump
Governor	Electronic
Aspiration	TA
Emission Standard	EU Stage II

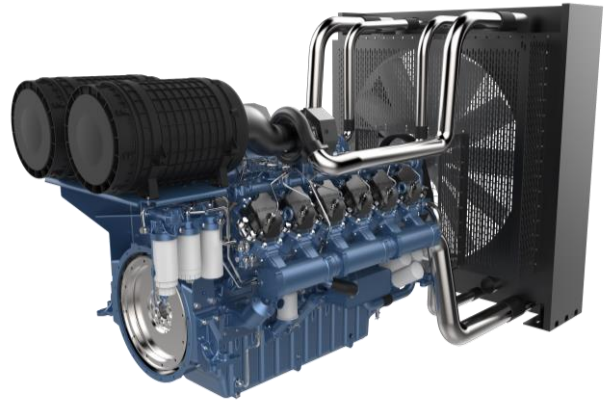

Engine Speed	Engine Output		Typical Generator Output(ESP)
	Prime(PRP)	Standby(ESP)	
RPM	kWm	kWm	kWe/kVA
1500	1007	1108	1000/1250
1500	1100	1210	1120/1400

Engine Speed	Engine Output		Typical Generator Output(ESP)
	Prime(PRP)	Standby(ESP)	
RPM	kWm	kWm	kWe/kVA
1800	1007	1108	1000/1250
1800	1150	1265	1100/1375
1800	1264	1390	1250/1563

Standard Equipment

Engine and block

- Cast iron cylinder block with inspection door per cylinder
- Cast iron cylinder liners, wet type and replaceable valves guides and seats
- Separate cast iron cylinder heads equipped with 4 valves
- Hardened steel forged crankshaft with induction hardened journals crankpins and radius
- Lube oil cooled light alloy pistons with high performance piston rings

Cooling system

- Thermostatically-controlled system with gear coolant pump and pusher fan

Lubrication system

- Full flow screwable oil filters
- Lube oil purifier with replaceable cartridge

Fresh water cooled lube oil cooler

Manual oil pump, pre-lubricate the engine and ensure good start ability.

Fuel system

- In line injection pump with flanged electronic governor
- Three-level filter integrated electric fuel pump, water separation filter

Air intake and exhaust system

- Exhaust manifold and turbocharger shield heat isolate
- Air filter and compressor pipe made in injection moulding

Electrical system

- 24V electric starter motor and battery charging alternator

Flywheel and housing

- SAE 0 flywheel housing and 18" flywheel

	Continuous Power(COP)	Prime Power(PRP)	Standby Power(ESP)
Mean engine load factor	100%	≤70% per 250 h	≤80% per 24 h
Annual working time	Unlimited	Unlimited	≤200 h
Time at full load	Unlimited(Max. load≤0.85PRP)	≤500 h per year	≤25 h per year
Overload capacity	NO	1 h per 12 h(10% overload) ≤25h per year	No

PowerKit Engine 12M33 Series

Dimensions and Weight

Length	3487mm
Width	2194mm
Height	2246mm
Weight	4360kg

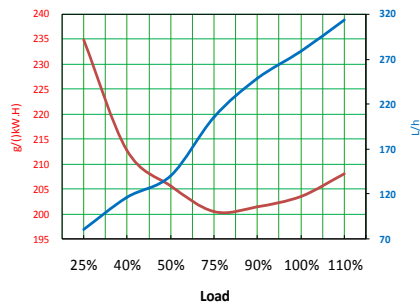
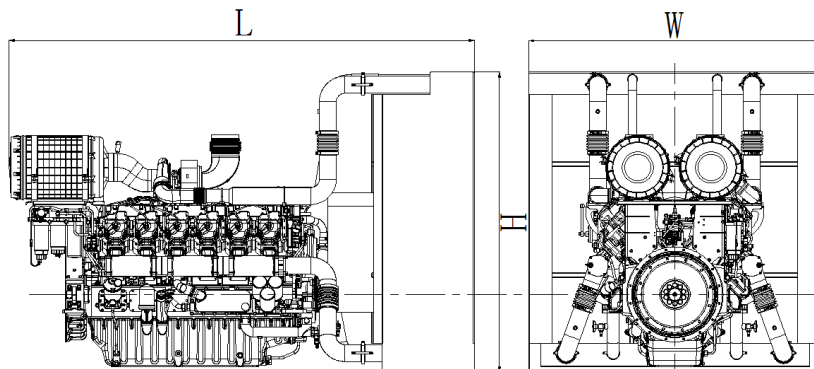

12M33G1250/5e2-1007kW/1500rpm

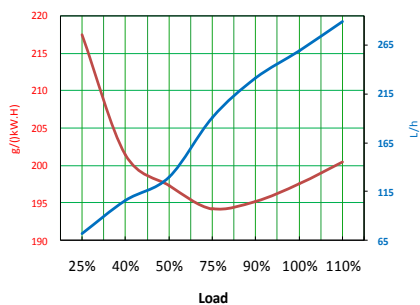

12M33G1400/5e2-1100kW/1500rpm

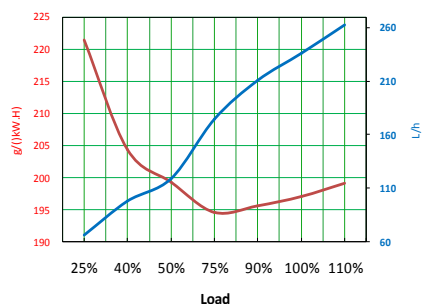

12M33G900/6e2-1007kW/1800rpm

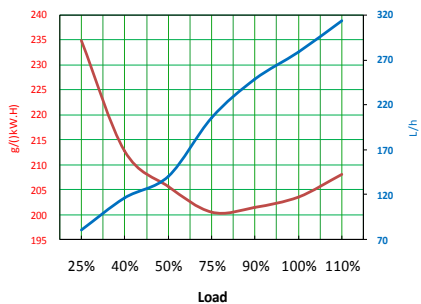

12M33G1000/6e2-1150kW/1800rpm

Power definition

Standard ISO 3046/1 -1995(F)

Reference conditions

Ambient temperature	25°C
Barometric pressure	100kPa
Relative humidity	30%

Fuel

Relativedensity	0.840kg/L
Lower calorific power	42 700 kJ/kg
Consumption tolerances	± 5 %

Lube oil

Recommend grade	CF 15W/40
-----------------	-----------

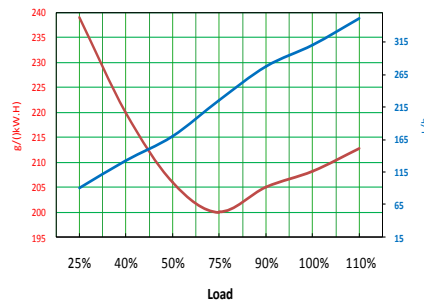

12M33G1135/6e2-1264kW/1800rpm

Manufacturer: SOCIETE INTERNATIONALE DES MOTEURS BAUDOIN
 Address: Technoparc du Bregadan
 13260 Cassis, FRANCE